

# XS7490FG6

75 cm, FRIDGE, OFR Model

BUILT-IN

X-PRO® SERIE

*Fhiaba*



## FEATURES

- Made in Italy.
- Aisi 304 stainless steel body.
- Stainless steel interior finish
- Antibacterial stainless steel interior.
- Evenlift: shelves can slide up and down to be adjusted to any height in the fridge compartment.
- Provent ventilation system encourages uniform distribution of cold air in all fridge compartments by laterally circulation air.
- Equilance: dual - movemenet patented hinge with self - balancing movement ensures stability and resistance.
- Optiview: multi - LED light array (top and side interior) provides brilliant illumination to the entire interior.
- Soft close door and drawers in all compartments
- Smart touch TFT display
- Acoustic and visual signals
- Total no frost 100% automatic system
- Insulated variavle speed compressors manteins precision temperature control with low vibration.
- Sabbath mode
- Front and rear adjustable feet up to 25 mm.
- One independent climatic zone.
- Tempered glass shelves with aluminium profiles.
- Crisper drawers for multi - use preservazion solution. Antibacterial stainless steel interior & rounded corners promoting hygiene and easy cleaning.
- Deep capacity within a standard depth is achieved by a side - mounted evaporators, wich leaves grater interior space.
- Full range of models and configurations ( 18", 24", 30" and 36"). Can easily be combined and configured with other Fhiaba fridge, freezer, wine cellar models to fit your kitchen needs.

## GENERAL PROPERTIES

Reversible door	NO
Equilance	YES
SoftClosing Runner	YES
Low vibration	YES
Optiview (LED light spots)	YES
Shelves	3
Slide-out shelves	NO
Type of shelves	GLASS
Door Bins	
Fridge drawers type	LOW TEMP
Fresco/LowTemp Drawers	3
Bottom drawers	
Full Extension shelves 90° door opening	
Full Extension drawers 90° door opening	YES
Defrost Process	AUTOMATIC
Ice maker with water filter	NO
Door Open Alarms	YES
Humidity control	NO
Active carbon filter	NO
Air filter control	NO
Shopping Fridge	YES
Shopping Freezer	NO
Power Failure Function	YES

# XS7490FG6

75 cm, FRIDGE, OFR Model

BUILT-IN

X-PRO® SERIE

## PRODUCT DETAIL

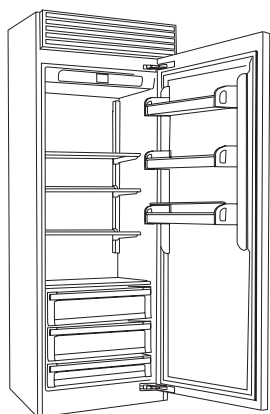

# Fhiaba

OF



1D | 1M

fridge

D = door

M = separate microclimates

### CAPACITY

Volume Compartment 1 (L)	479
Volume Compartment 2 (L)	
Volume Compartment 3 (L)	
Total Net Volume (L)	479
Total Gross Volume (L)	489
Compartment 1 / Upper wine cellar capacity (bottles)	
Compartment 2 / Lower wine cellar capacity (bottles)	
Compartment 3 / Bottom wine cellar capacity (bottles)	

### TECHNICAL DETAILS

Absorbed power (W)	
Total absorbed current (A)	0.7
Voltage (V)	220-240V
Frequency (Hz)	50-60 Hz
Power Cord Length (mm)	2
Plug Type	Schuko 16A
Climatic class	SN/T
Noise level (dB)	41
Refrigerant (gas)	R600a
Water connection / female attachment	-

### EFFICIENCY

New Energy Label class	F
Energy consumption (kWh/year)	168

### DIMENSIONS & WEIGHT

Height of the product (closed weels) (mm)	2120
Adjustable feet height (mm)	25
Width of the product (mm)	749
Depth of Product without handle (mm)	640
Wall cavity height (mm)	2134
Wall cavity width (mm)	750
Wall cavity depth (mm)	650
Net Weight (kg)	162
Gross Weight (kg)	183

### TEMPERATURE RANGES

Climatic compartments	1
Compartment 1 / Upper temperature (°C)	from 2 to 8
Compartment 2 / Middle temperature (°C)	
Low temp zone	YES
Compartment 3 / Low temperature (°C)	
Dual zone	NO

# XS7490FG6

75 cm, FRIDGE, OFR Model

BUILT-IN

X-PRO® SERIE

## PRODUCT SPECIFICATIONS AND DIMENSIONS

*Fhiaba*

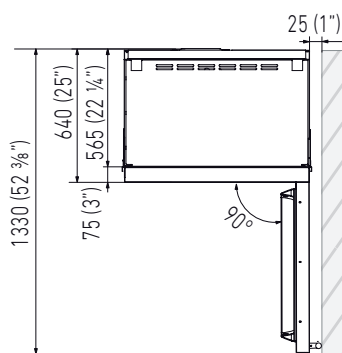
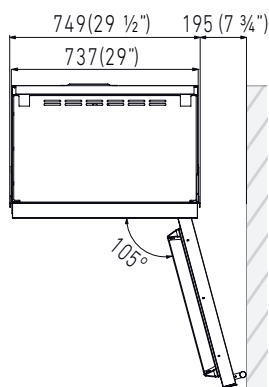
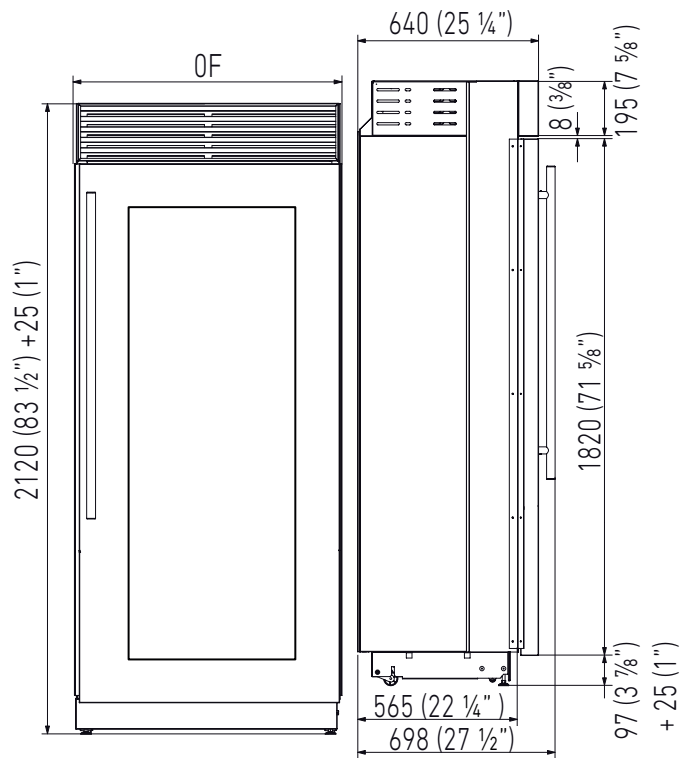

**i** For installation specifications, please consult with Fhiaba. For optimum installation, we recommend using the actual product as the best guide.

**i** Based on the adjustment of the feet and the height of the panel from the floor, the customer defines the perforated plinth to be installed on the equipment.

# XS7490FG6

75 cm, FRIDGE, OFR Model

BUILT-IN

X-PRO® SERIE

## NICHE SPECIFICATIONS AND DIMENSIONS

*Fhiaba*

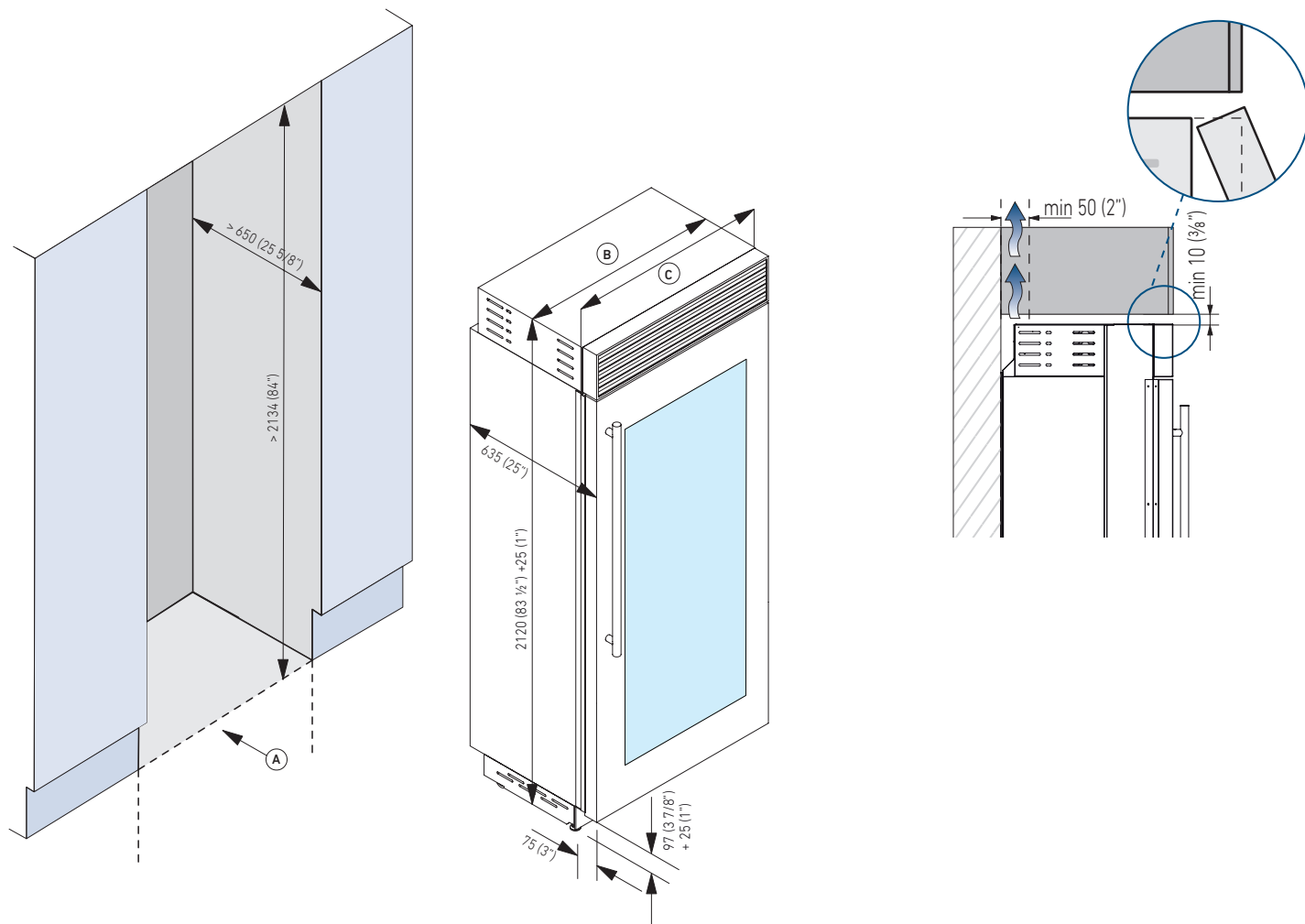

TECHNICAL DATA	
Niche Width <b>A</b> (mm)	750
Unit Width <b>B</b> (mm)	737
Unit Width with lateral frames <b>C</b> (mm)	749

### Electrical and Water connection

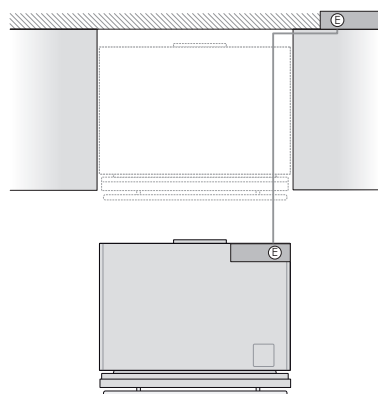

### Electrical and Water connection behind the unit

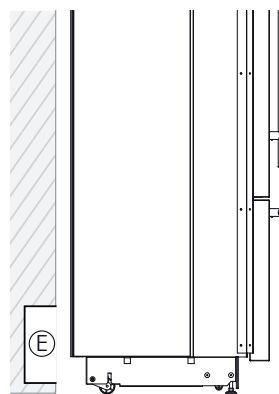

# XS7490FG6

75 cm, FRIDGE, OFR Model

BUILT-IN

X-PRO® SERIE

## INSTALLATION INFORMATION

*Fhiaba*

### Side by side installation

- 1 - Device 1
- 2 - Device 2
- 3 - Joining kit
- A - Niche device 1
- B - Niche device 2

### ACCESSORIES

- Stainless steel sides panels
- Glass door
- Joining kit
- X-Pro top grille kit
- Extra length anti-tipping kit
- Anticondensation kit
- Cleaning kit
- FLD - Fhiaba Link Device
- Painting
- 90° Door stop

 For installation specifications, please consult with Fhiaba.  
For optimum installation, we recommend using the actual product as the best guide.

     
[www.fhiaba.com](http://www.fhiaba.com)