

S8990HWT3

90 cm, DUAL COMPARTMENT WINE CELLAR, 0H Model

BUILT-IN

INTEGRATED® SERIE

Fhiaba



FEATURES

- Made in Italy.
- Aisi 304 stainless steel body.
- Stainless steel interior finish
- Antibacterial stainless steel interior.
- Provent ventilation system encourages uniform distribution of cold air in all fridge compartments by laterally circulation air.
- Equilance: dual - movemenet patented hinge with self - balancing movement ensures stability and resistance.
- Optiview: multi - LED light array (top and side interior) provides brilliant illumination to the entire interior.
- Smart touch TFT display
- Acoustic and visual signals
- Total no frost 100% automatic system
- Insulated variavle speed compressors manteins precision temperature control with low vibration.
- Sabbath mode
- Front and rear adjustable feet up to 25 mm.
- Two indipendent climatic zone.
- Deep capacity within a standard depth is achieved by a side - mounted evaporators, wich leaves grater interior space.
- Full range of models and configurations (45, 60, 75 and 90 cm). Can easily be combined and configured with other Fhiaba fridge, freezer, wine cellar models to fit your kitchen needs.
- Triple-pane, bronzed glass door guarantees maximun protection from harmful UV light rays.
- Soft - close mechanisms on every oak wine rack.
- Humidity control

GENERAL PROPERTIES

Reversible door	NO
Equilance	YES
SoftClosing Runner	NO
Low vibration	YES
Optiview (LED light spots)	YES
Shelves	9
Slide-out shelves	YES
Type of shelves	WOOD
Door Bins	
Fridge drawers type	
Fresco/LowTemp Drawers	
Bottom drawers	2
Full Extension shelves 90° door opening	YES
Full Extension drawers 90° door opening	NO
Defrost Process	AUTOMATIC
Ice maker with water filter	NO
Door Open Alarms	YES
Humidity control	YES
Active carbon filter	YES
Air filter control	NO
Shopping Fridge	NO
Shopping Freezer	YES
Power Failure Function	YES

S8990HWT3

90 cm, DUAL COMPARTMENT WINE CELLAR, 0H Model

BUILT-IN

INTEGRATED® SERIE

PRODUCT DETAIL

Fhiaba

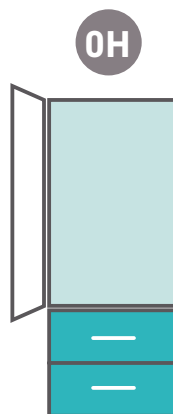
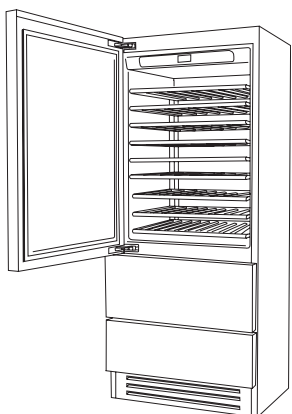

1D | 2BD | 2M

D = door

BD = drawer

M = separate microclimates

CAPACITY

Volume Compartment 1 (L)	357
Volume Compartment 2 (L)	
Volume Compartment 3 (L)	167
Total Net Volume (L)	524
Total Gross Volume (L)	542
Compartment 1 / Upper wine cellar capacity (bottles)	108
Compartment 2 / Lower wine cellar capacity (bottles)	
Compartment 3 / Bottom wine cellar capacity (bottles)	

TECHNICAL DETAILS

Absorbed power (W)	
Total absorbed current (A)	1.23
Voltage (V)	220-240V
Frequency (Hz)	50-60 Hz
Power Cord Length (mm)	2
Plug Type	Schuko 16A
Climatic class	SN/T
Noise level (dB)	41
Refrigerant (gas)	R600a
Water connection / female attachment	-

EFFICIENCY

New Energy Label class	G
Energy consumption (kWh/year)	197

DIMENSIONS & WEIGHT

Height of the product (closed weels) (mm)	2050
Adjustable feet height (mm)	25
Width of the product (mm)	899
Depth of Product without handle (mm)	610
Wall cavity height (mm)	2064
Wall cavity width (mm)	900
Wall cavity depth (mm)	650
Net Weight (kg)	181
Gross Weight (kg)	202

TEMPERATURE RANGES

Climatic compartments	2
Compartment 1 / Upper temperature (°C)	from 4 to 18
Compartment 2 / Middle temperature (°C)	
Low temp zone	NO
Compartment 3 / Low temperature (°C)	from -15 to -22
Dual zone	YES

S8990HWT3

90 cm, DUAL COMPARTMENT WINE CELLAR, 0H Model

BUILT-IN

INTEGRATED® SERIE

PRODUCT SPECIFICATIONS AND DIMENSIONS

Fhiaba

FRONT VIEW

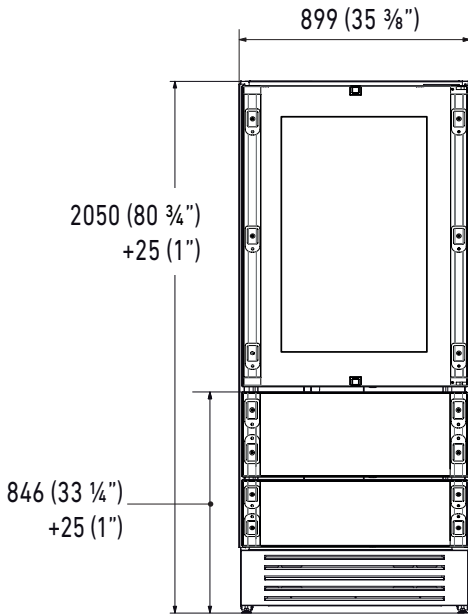

SIDE VIEW

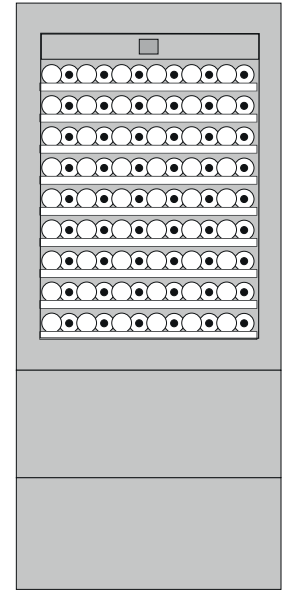
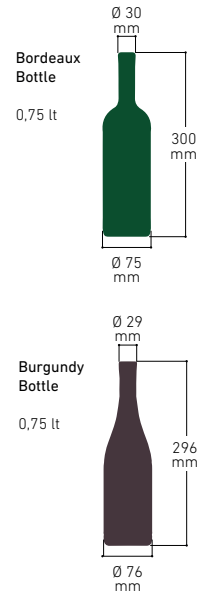
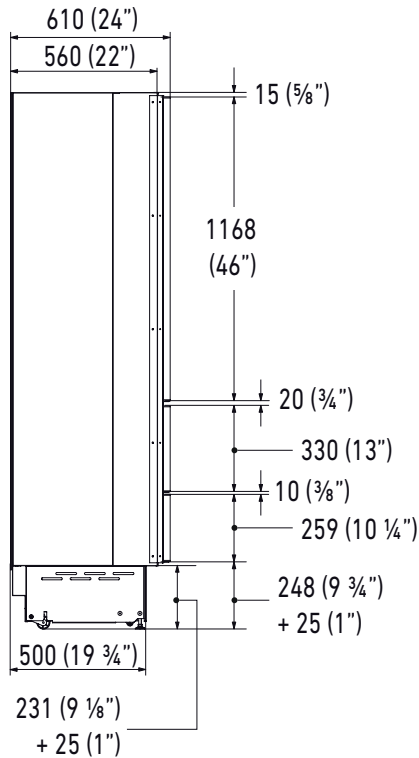

TOP VIEW,
HINGE 105°

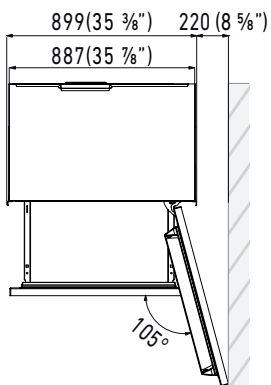

TOP VIEW,
HINGE 90°

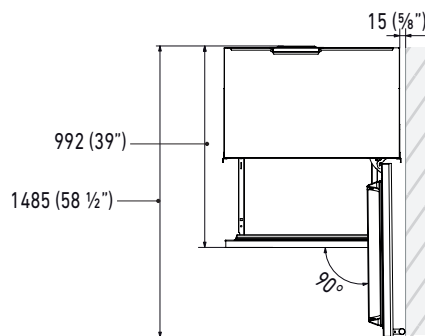

PLINTH SIZE

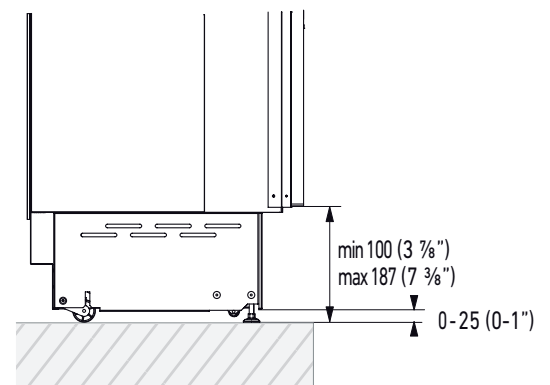

i For installation specifications, please consult with Fhiaba. For optimum installation, we recommend using the actual product as the best guide.

i Based on the adjustment of the feet and the height of the panel from the floor, the customer defines the perforated plinth to be installed on the equipment.

S8990HWT3

90 cm, DUAL COMPARTMENT WINE CELLAR, 0H Model

BUILT-IN

INTEGRATED® SERIE

NICHE SPECIFICATIONS AND DIMENSIONS

Fhiaba

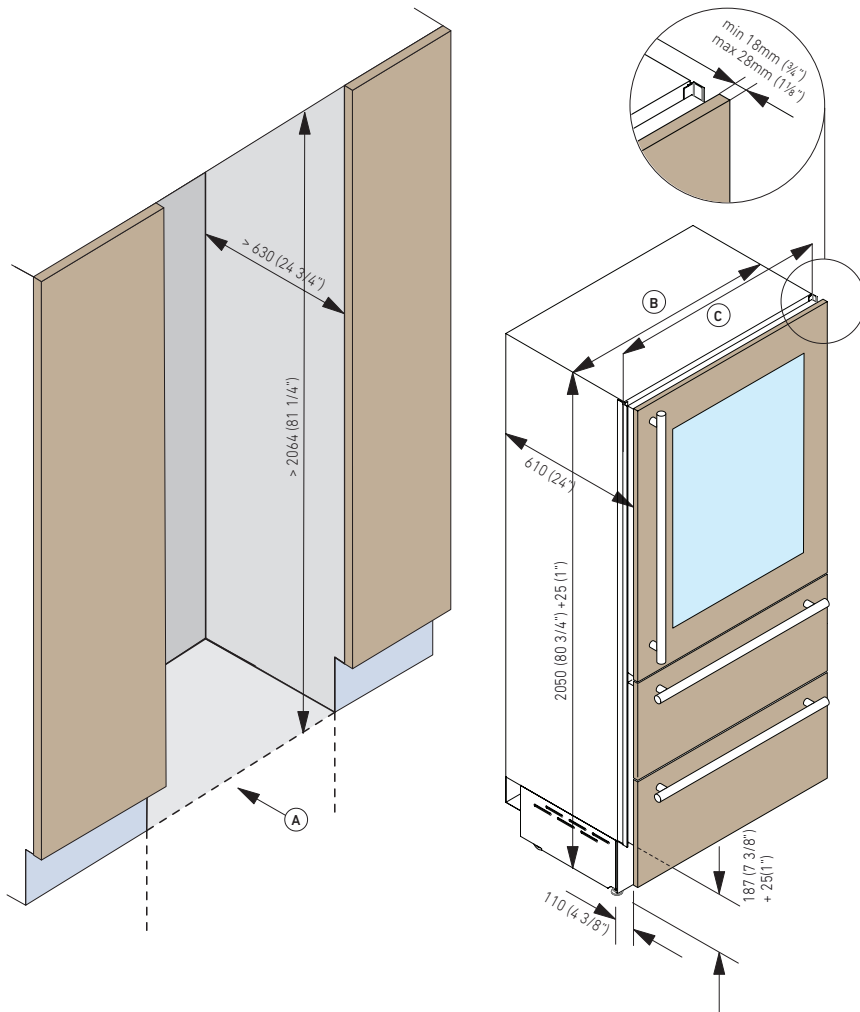

TECHNICAL DATA	
Niche Width A (mm)	900
Unit Width B (mm)	887
Unit Width with lateral frames C (mm)	899

Electrical and Water connection



S8990HWT3

90 cm, DUAL COMPARTMENT WINE CELLAR, 0H Model

BUILT-IN

INTEGRATED® SERIE

CUSTOM PANELS INFORMATION

Fhiaba

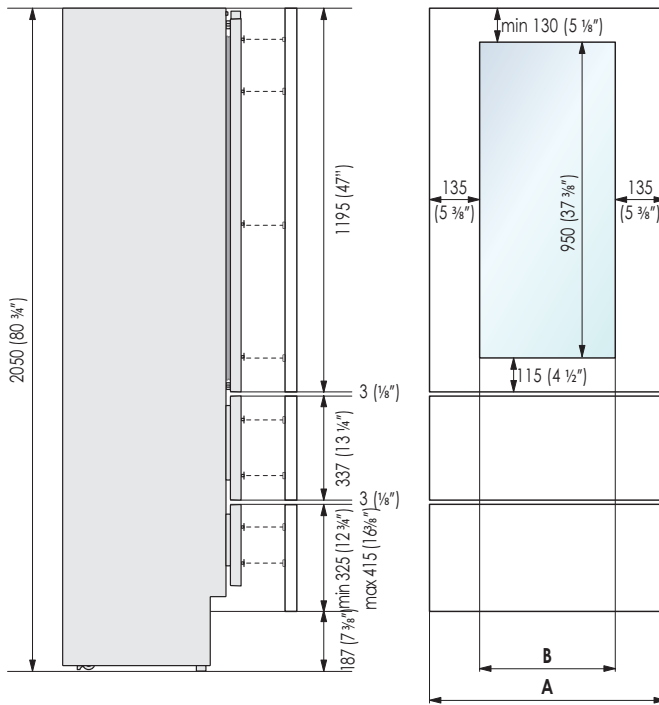

Serie	A	B
899 (90 cm)	897 (35 1/4")	627 (24 3/4")



Integrated Panel Recommendations

Panels with thickness ranging between 18 mm and 28 mm.
 Door panels with weight max of 23 kg and drawer panels with weight max of 11 kg. Provide installation of decorative panels during installation of the unit.



For installation specifications, please consult with Fhiaba.
 For optimum installation, we recommend using the actual product as the best guide.

S8990HWT3

90 cm, DUAL COMPARTMENT WINE CELLAR, 0H Model

BUILT-IN

INTEGRATED® SERIE

INSTALLATION INFORMATION

Fhiaba

Niche dimensions for combined installation

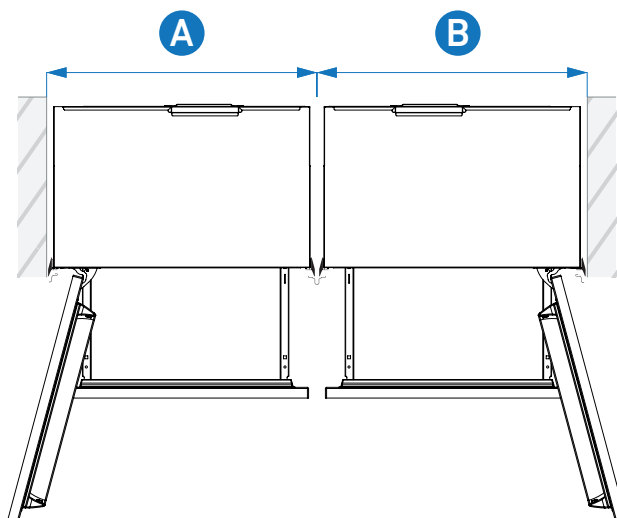

		A				
B		unit size	45	60	75	90
B	45	90 cm	105 cm	120 cm	135 cm	150 cm
	60	105 cm	120 cm	135 cm	150 cm	165 cm
	75	120 cm	135 cm	150 cm	165 cm	180 cm
	90	135 cm	150 cm	165 cm	180 cm	

ACCESSORIES

- Stainless steel sides panels
- Glass door
- Joining kit
- Stainless steel tubular handleless 30mm
- Stainless steel tubular handleless 18mm
- Stainless steel panels
- Stainless steel portal for freestanding
- Extra length anti-tipping kit
- Anticondensation kit
- Cleaning kit
- Active carbon filter
- FLD - Fhiaba Link Device
- Front ventilation kit
- 90° Door stop
- Push / pull opening
- Wine kit
- Cheese drawer
- Set of knives
- Prosciutteria kit
- Bottle trap
- Sigar drawer
- Beverage drawer
- Beverage shelf
- Beverage removable shelf

 For installation specifications, please consult with Fhiaba. For optimum installation, we recommend using the actual product as the best guide.

   
www.fhiaba.com